

# MG-AFL Adjustable Flood Light

## Description

The Adjustable Flood Light is ideally suited for warehouses and sports fields as well as use on high masts

## Environment

Outdoor/Indoor

## Installation

To be surface mounted or suspended.

## Application

For use in warehouse, sports fields and other similar applications.



## General Data

Voltage	100-247V 50-60Hz
Power Factor	>0.95
Light Source	Philips Lumileds
Driver	Meanwell
CCT	2700-6500K
LED Lifetime	50,000hrs/L70
Operating temp	-40°C to 60°C

## Light Data

Lumens per Watt	140lm/W
Light Source	LED
CRI	>80
Distribution	45°, 75°, 120°

# MG-AFL Adjustable Flood Light

## Product Variants

Product Code	System Power (W)	Lumens (lm)	Length (mm)	Width (mm)	Height (mm)	Weight (Kg)
MGAF75	75	10500	237	102	162	2.1
MGAF150	150	21000	295	210	274	3.5
MGAF240	240	33600	295	319	274	5
MGAF300	300	42000	488	210	274	6.3
MGAF480	480	67200	489	319	374	8.1

## Options

OPTION	CODE
CCT 2700K -6000K	E.g. /4K
Marine Grade	MG
Beam Angles - 45deg, 75deg, 120deg	/45D, /75D, /120D

## Features



Multiple optical lens choices are available

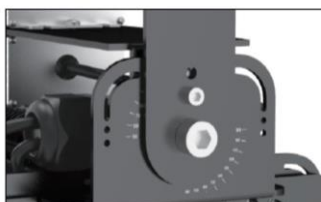

◀ Bracket scale

Scale Module ▶



# MG-AFL Adjustable Flood Light

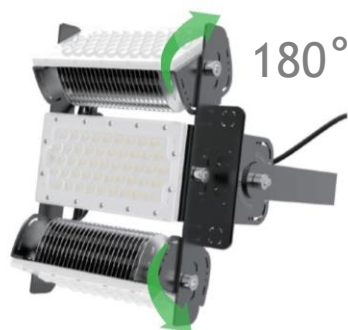

Module rotatable 180°

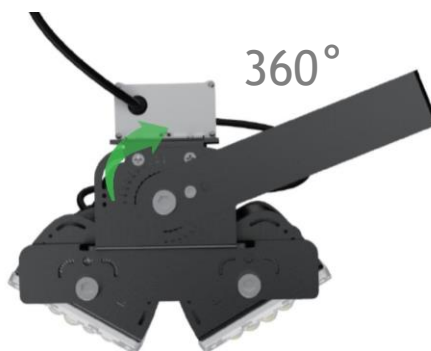

Arm bracket rotatable 360°

## Photometrics

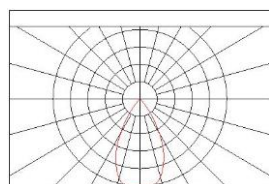

45°

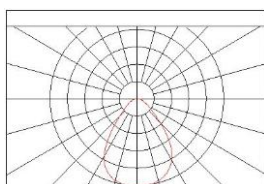

75°

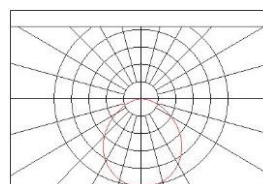

120°

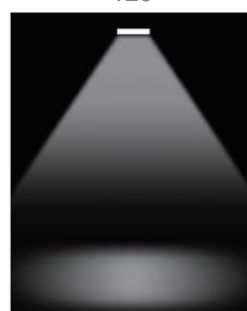

## Installation

